

Sink S1000

Kitchen Sinks

Code: 1186 161



DETAILS

Edge/Installation Type Standard (8 mm Edge)

Finish Foster brushed

Material AISI 304 stainless steel

Texture Foster brushed

Base 45 cm

Dimensions 860x500 mm

Standard fittings Fixing hooks, gasket, drain, overflow and siphon, boxed packing

Mixer holes 1 standard hole

Built-in hole 840x480 mm

Drainer Yes

Width 86 cm

Bowl dimension 340x400mm

Number of bowls 1 bowl

Waste fitting 3,5" drain

FEATURES

Added value Foster uses steel thicknesses higher than those used on average by other manufacturers. This is how, thanks to our long experience, we know how to make sinks of superior quality and with a better resistance to aging.

Basket 3,5" waste fitting The drain is equipped with a large 3.5" drain, with the practical basket cap that prevents the discharge of solid parts.

Sliding brackets

TECHNICAL DATA

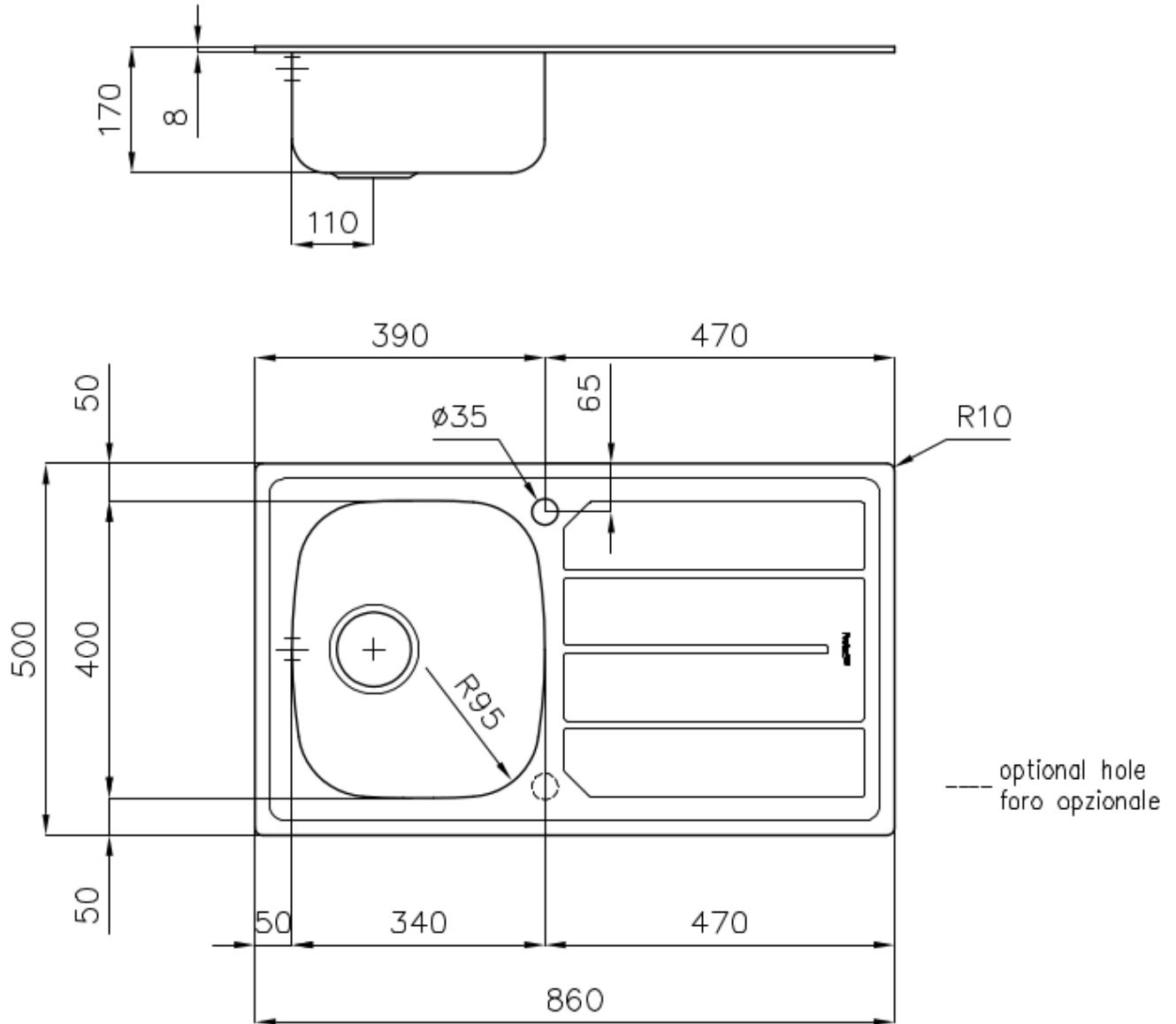

GALLERY



OPTIONAL ACCESSORIES



HPDE Chopping board



Iroko-wood sliding chopping board



Stainless steel basket

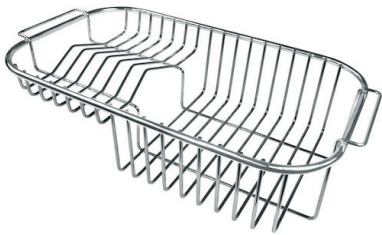

Stainless steel plate rack

RECOMMENDED PAIRINGS



Mixer Tap Lorenzo



Mixer Tap S1000 - RO